



Pedestal Series Checkouts



Model PS1101 Pedestal Scan and Pass checkouts with Terminal stand

Model PS1101 Pedestal Scan and Pass checkout with terminal stand

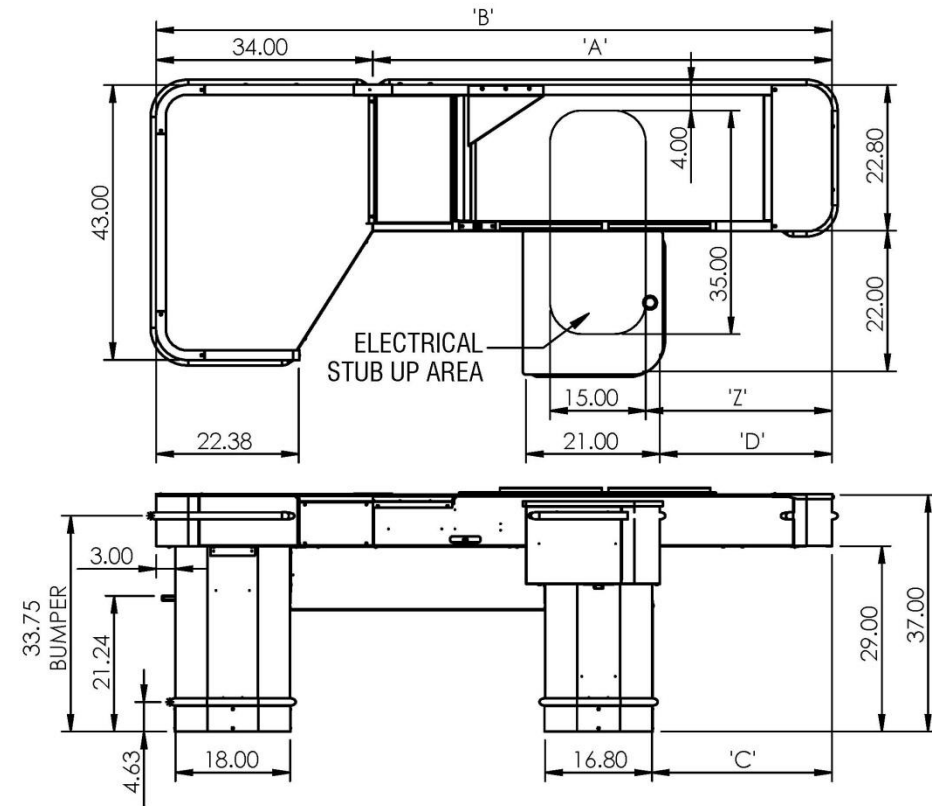
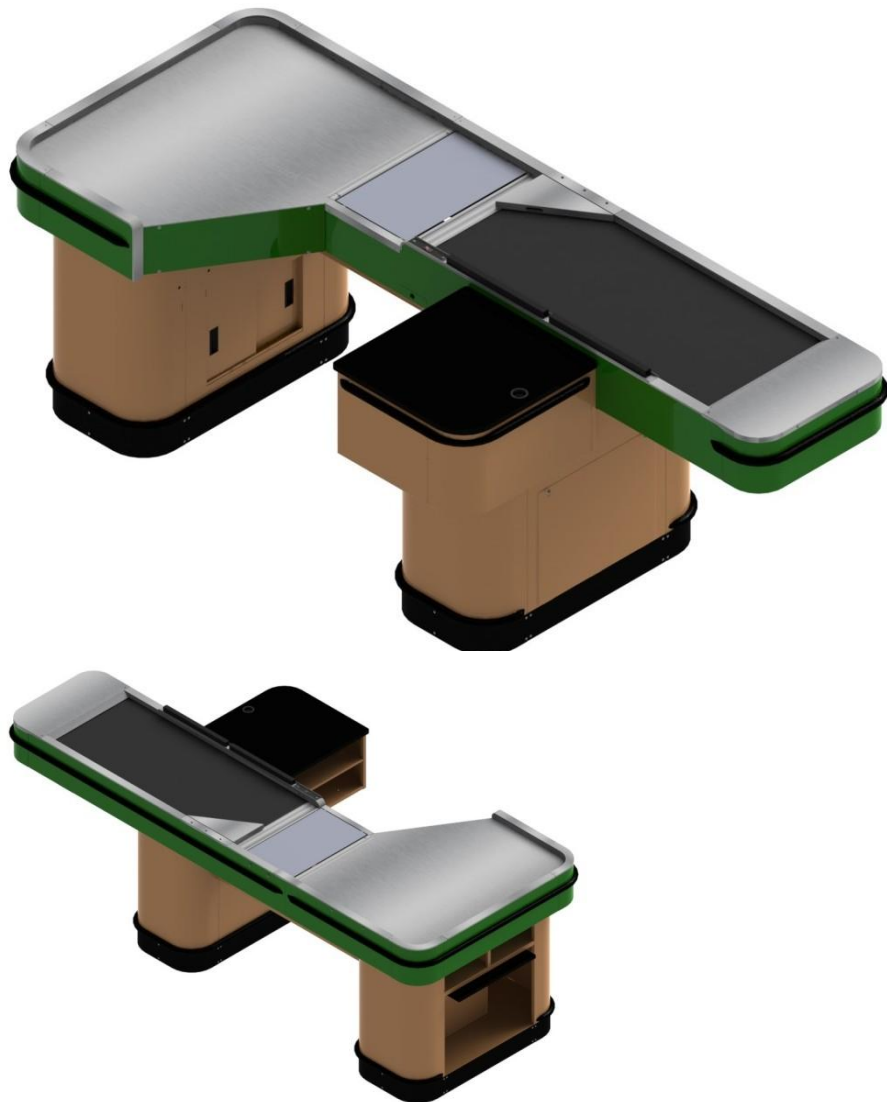

CONVEYOR LENGTH (FT.)	DIMENSION (IN.)				STUB UP
	A	B	C	D	
8'	96.00	130.00	52.20	51.00	53.10
7'	84.00	118.00	40.20	39.00	41.10
6'	72.00	106.00	28.20	27.00	29.10
5'	60.00	94.00	21.08	19.90	21.98
4'	48.00	82.00	9.08	7.90	9.98



Model PS1102 Pedestal Scan and Pass Checkouts without Terminal stand

Model PS1102 Pedestal Scan and Pass checkout without terminal stand

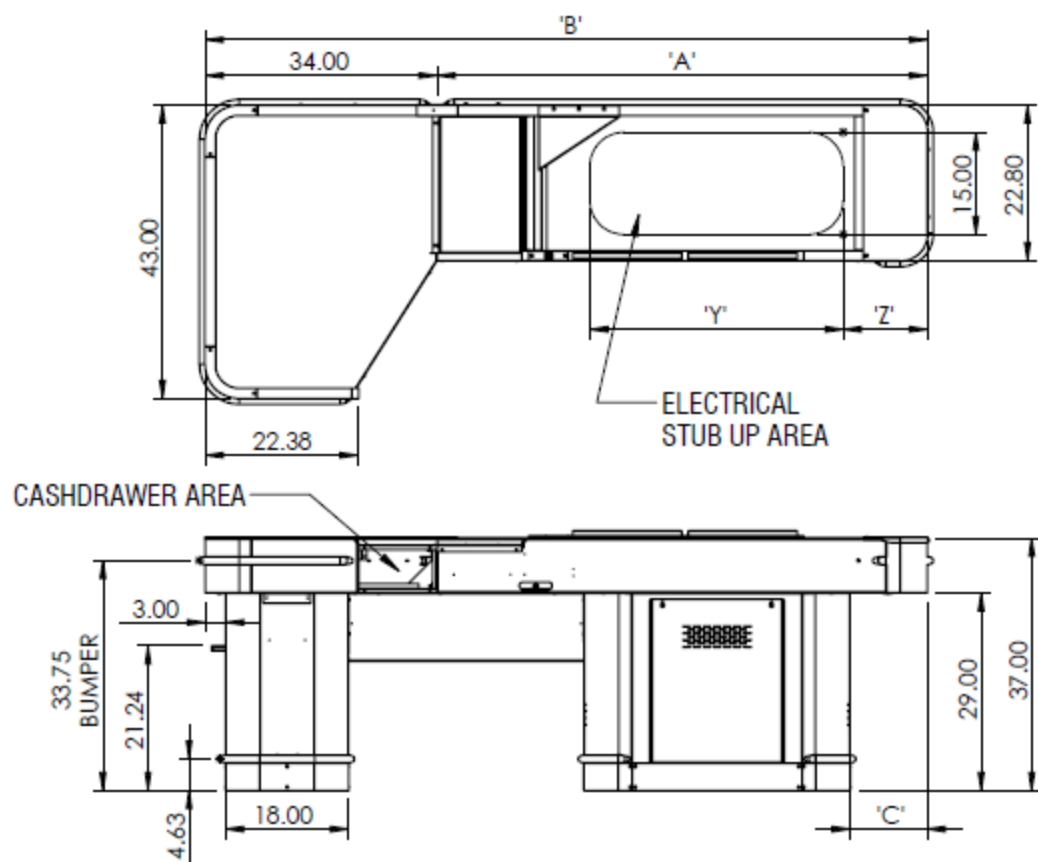
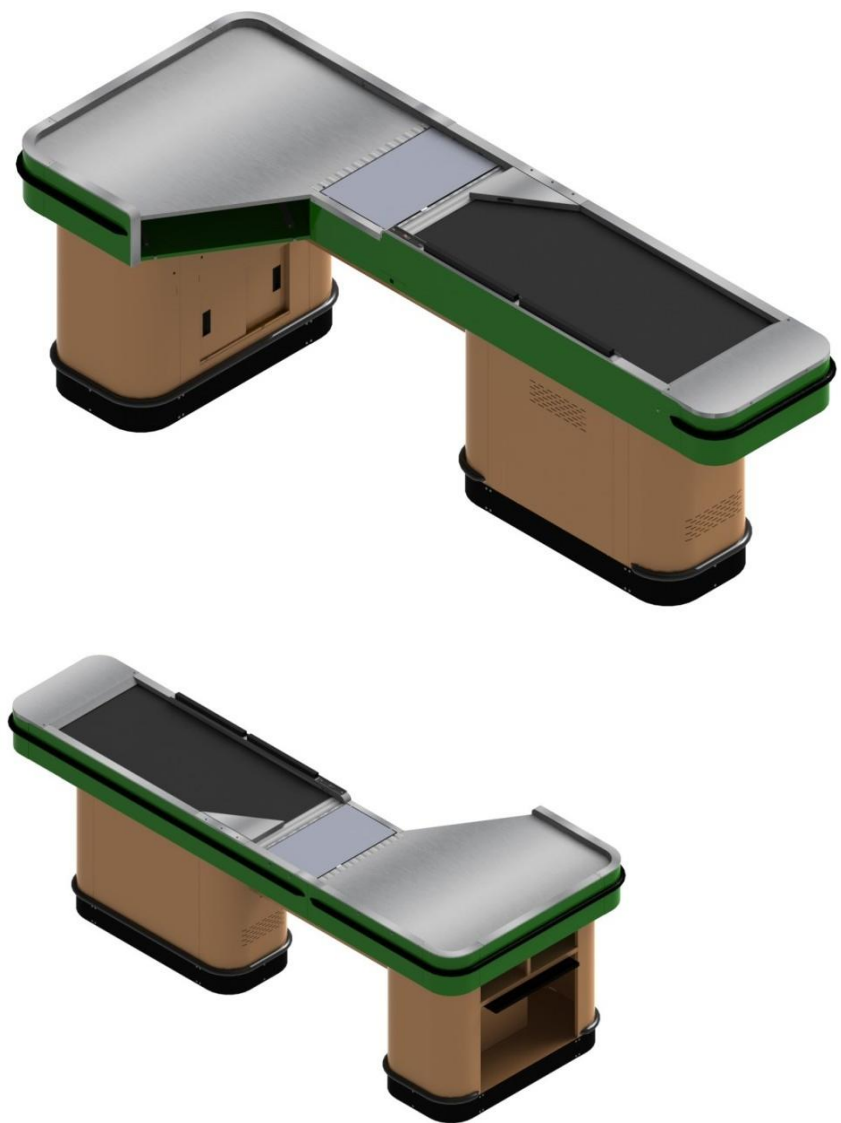

CONVEYOR LENGTH (FT.)	DIMENSION (IN.)			STUB UP	
	A	B	C	Y	Z
8'	96.00	130.00	26.00	37.20	26.90
7'	84.00	118.00	14.00	37.20	14.90
6'	72.00	106.00	11.38	37.20	12.28
5'	60.00	94.00	7.38	29.20	8.28
4'	48.00	82.00	0.38	29.20	1.28

Value Series standard Product Features



Multiple Conveyor lengths available

Clean and Dirty Power

Connection boxes for easy electrical connections.

Order divider bars and holder

Photo electric eye belt controls

Pull out bagging shelf

Bumper Rail protection

Fully customizable with multiple add on options

PS 1102 features a cashdrawer housing in the rear section

Welded construction for added durability and longevity

Durable textured Powder Coat Paint

Heavy Duty 18 Ga construction

Stainless Steel bagging decks

Power Outlets installed

Wire access holes

Scanner trim kit



Additional available Options

Additional Features and Options available

Product Diverter

Keyboard tray holders

Check shelf 6x12

Check shelf EFT holder 9.5 X 19

Power Poles

Lane Lights

Monitor stands rail and deck mounted

Next order dividers

Aisle Close Offs

Additional Features and Options

R767
MONITOR STAND
SADDLE MOUNT

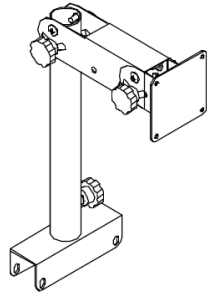

AR767-010
MONITOR POST
SADDLE MOUNT

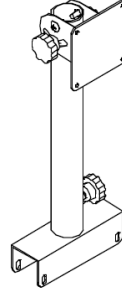

AR767-020
MONITOR POST
DECK MOUNT

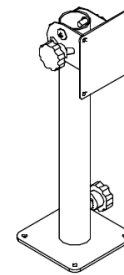

P640
KEYBOARD STAND

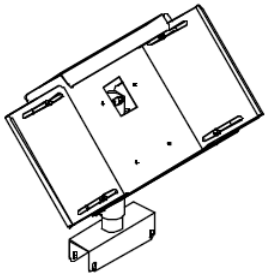

P318-012
MIRROR PANEL

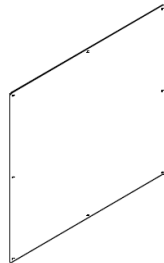

ARO65-025
CHECK SHELF

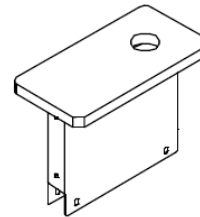

ARO65-030
CHECK SHELF

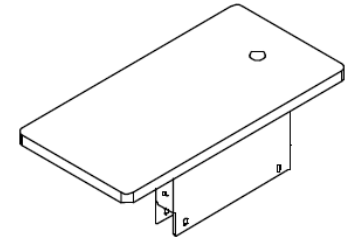

Additional Features and Options

LRO00001
LANE LIGHT
RED

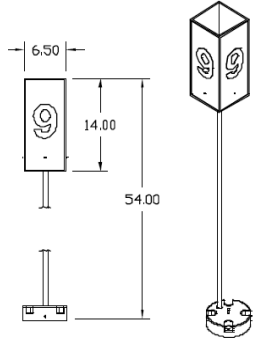

LW000001
LANE LIGHT
WHITE

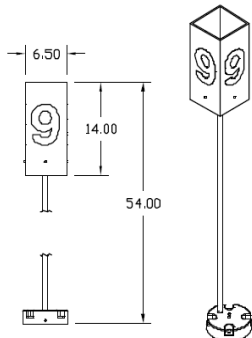

LB000001
LANE LIGHT
BLUE W/ STRIPE

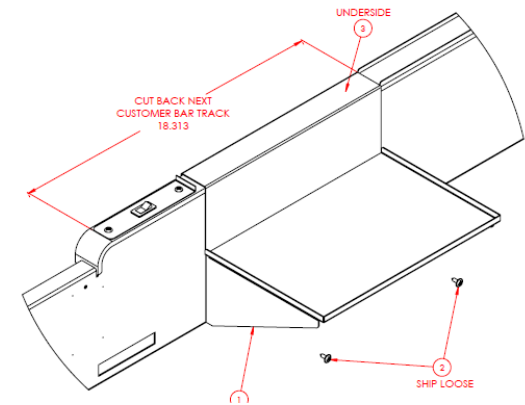
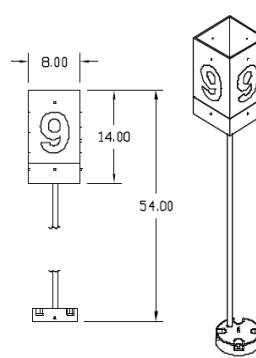

Printer Shelf AS062-100

738QA1049
AISLE CLOSE OFF

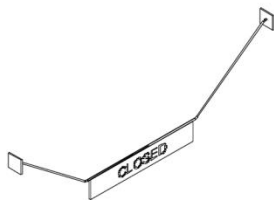

AP647-036
PRODUCT DIVERTER (LH)

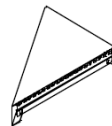

AR049-036
PRODUCT DIVERTER (RH)

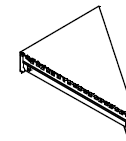

To place an order or request a quote please indicate the following information.

Model number : example **PS1101**

Left hand or Right hand configuration

Example **PS1101-L** for Left hand and **PS1101-R** for right hand

Indicate conveyor length : example **PS1101-L-7** for a 7 foot long conveyor section.

List all additional option by part number

Indicate scanner make and model number as well as paint color